



# User Guide

Pan/Tilt Home Security Wi-Fi Camera  
Tapo C210

# Contents

|   |    |
|---|----|
| About This Guide .....                          | 1  |
| Introduction .....                              | 2  |
| Appearance .....                                | 3  |
| Set Up Your Camera .....                        | 4  |
| Setup using Amazon Frustration-Free Setup ..... | 6  |
| Main Camera Controls .....                      | 10 |
| Pan & Tilt Control .....                        | 12 |
| Motion Detection .....                          | 13 |
| 24-hour Recordings .....                        | 17 |
| Privacy Mode .....                              | 19 |
| Authentication .....                            | 20 |

# About This Guide

This guide provides a brief introduction to the Pan/Tilt Home Security Wi-Fi Camera and the Tapo app, as well as regulatory information.

Please note that features available in Tapo may vary by model and software version. Tapo availability may also vary by region. All images, steps, and descriptions in this guide are only examples and may not reflect your actual Tapo Camera experience.

## Conventions

In this guide, the following convention is used:

| Convention       | Description  |
|------------------|--|
| Blue             | Key information appears in teal, including management page text such as menus, items, buttons and so on. |
| <u>Underline</u> | Hyperlinks are in teal and underlined. You can click to redirect to a website.                           |
| 📌Note:           | Ignoring this type of note might result in a malfunction or damage to the device.                        |

## More Info

- Specifications can be found on the product page at <https://www.tapo.com>.
- Our Technical Support and troubleshooting information can be found at <https://www.tapo.com/support/>.
- The setup video can be found at <https://www.tp-link.com/support/setup-video/#cloud-cameras>.

# Introduction

When you are away home, there are always something you care about. This is where the smart camera functions. No matter your child is climbing the kitchen cabinet, or the pet is stealing snacks, the Pan/Tilt Home Security Wi-Fi Camera helps you stay with them anytime, anywhere. Receive a notification whenever your camera detects motion and see a video clip of this motion to check everything.

- **Smooth Pan and Tilt** – 360° horizontal range.
- **3MP High-Definition** – Provide greater sharpness and clarity.
- **Advanced Night View** – Even at night, the camera can provide a visual distance of up to 30 ft.
- **Live View** – Always stay with what matters most to you from anywhere, anytime.
- **Two-Way Audio** – Communicate with others with the built-in microphone and speaker.
- **Sound and Light Alarm** – Trigger light and sound effects to frighten away unwanted visitors.
- **Privacy Mode** - Shut down the surveillance to protect your privacy.
- **Sharing** - Share the memorable moments with your family and friends.
- **Safe Storage** – Store up to 256 GB on a microSD card\*, equal to 512 hours (21 days) of footage<sup>△</sup>.

\*microSD card needs to be purchased separately. <sup>△</sup>The data comes from TP-Link laboratory.

# Appearance

The Pan/Tilt Home Security Wi-Fi Camera has a system LED that changes color according to its status, a lens, microphone, speaker, DC power port, RESET button, and a microSD card slot. Refer below for details.

## System LED

- **Solid red:**  
Starting up
- **Blinking red and green:**  
Ready for setup
- **Blinking red slowly:**  
Connecting to Wi-Fi
- **Solid amber:**  
Connected to Wi-Fi
- **Solid green:**  
Connected to TP-Link Cloud server
- **Blinking red quickly:**  
Camera resetting
- **Blinking green quickly:**  
Camera updating



## Microphone

Built-in internal microphone.

■ **Note:** Do NOT insert objects into the hole.



## Speaker

The sound comes out of the camera.

## DC Power Port

Connect the power cord provided.

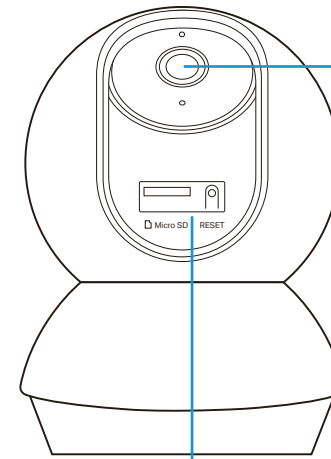

## Lens

Tilt your camera lens up to find the RESET button and microSD card slot.

- **RESET Button**

Press and hold for at least 5 seconds until the LED blinks red to reset your camera.

- **microSD Card Slot**

Insert a microSD card and initialize it in the Tapo app for local recording.

# Set Up Your Camera

Follow the steps below to get started with your new camera.

## Step 1. Download Tapo App

Get the [Tapo](#) app from the Apple App Store or Google Play, or by scanning the QR code below.



OR



## Step 2. Log In

Open the app, and log in with your TP-Link ID. If you don't have an account, create one first.

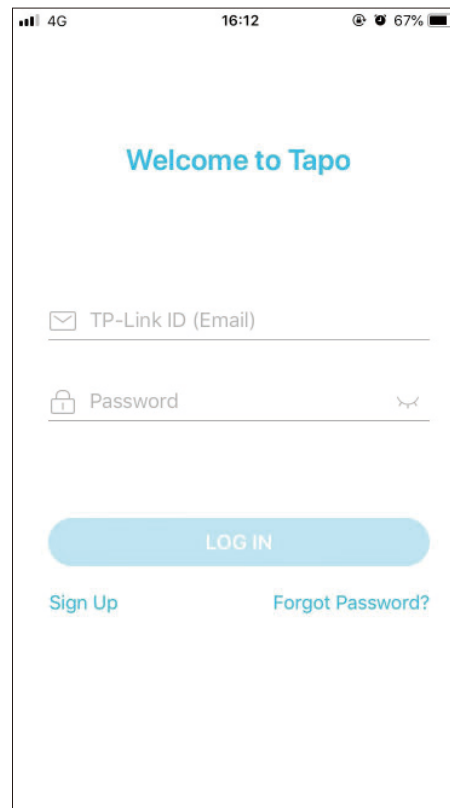

## Step 3. Add Your Camera

Tap the  $\oplus$  button in the app and select your model.

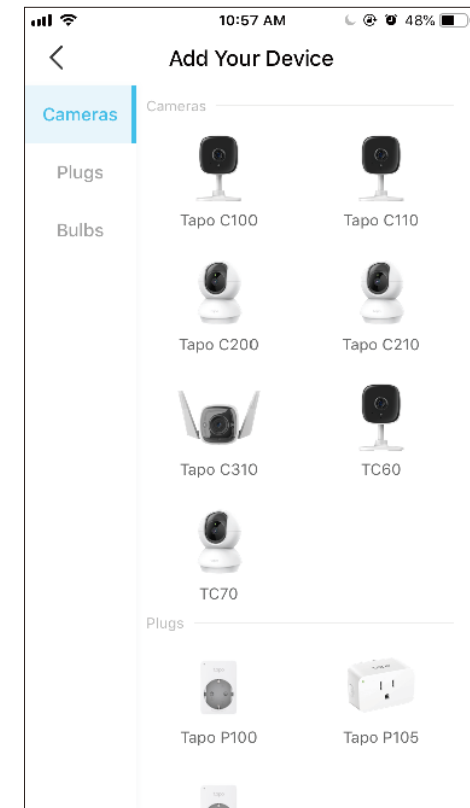

## Step 4. Configure Camera

Follow app instructions to configure your camera and add it to your home network.

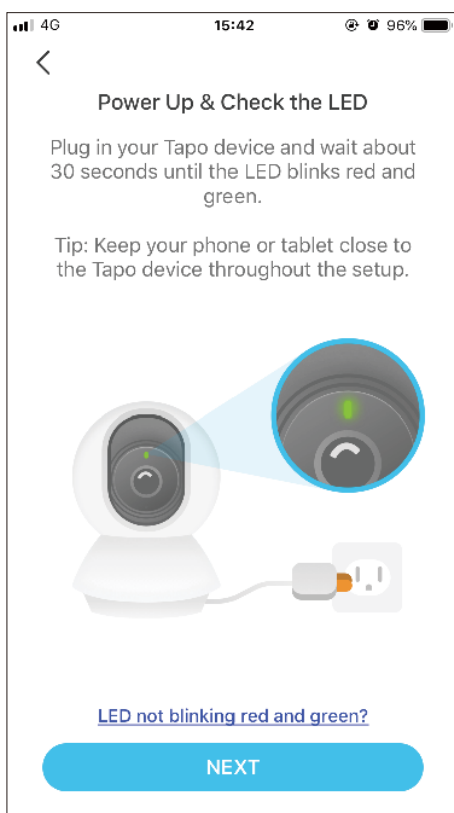

## Step 5. Place Camera

Place your camera on a flat surface, or install it on a wall or ceiling with the provided mounting template and screws.

■Note: Make sure you affix the camera base using screws **before** securing the camera.

### 1. Mark Position

Place the mounting template where you want the camera.  
For wall mounting, drill two holes through two circles.

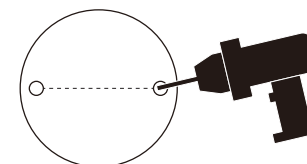

### 2. Mount Base

Affix the camera base using the screws.  
For wall mounting, insert two anchors into the holes and use the screws to affix the camera base over the anchors.

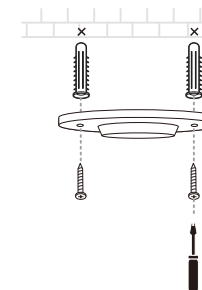

### 3. Secure Camera

Attach the camera on the base and rotate to secure the camera.

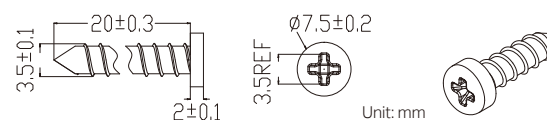
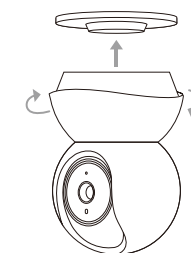

# Setup using Amazon Frustration-Free Setup

## What is Amazon Frustration-Free Setup?

Amazon Frustration-Free Setup can help connect and set up Tapo smart devices in fewer steps, without having to remember and re-enter your Wi-Fi password on each device.

To use this feature, confirm the following:

- The new Tapo device supports Amazon FFS.
- You have an Amazon FFS enabled Alexa device or router.
- You have saved your Wi-Fi information to Amazon by using Alexa echo.
- Your Tapo device and router are on the same network as your Alexa echo.

## LED Indications during Amazon Frustration-Free Setup

| LED                       | Status                |
|---------------------------|-----------------------|
| Blinking orange and green | Ready for setup       |
| Blinking orange           | FFS setup in progress |
| Solid green               | Working properly      |

If the LED does not turn solid green after a long time, you can try to add the Tapo device manually. (Press the Reset button on your Tapo device once. Then open the Tapo app, tap the + button on the page, select your device model, and follow the app instructions.)



## How to use Amazon Frustration-Free Setup with Tapo devices

1. Open the [Amazon Alexa](#) app. Then tap on the hamburger icon in the upper left corner and select [Skills & Games](#).

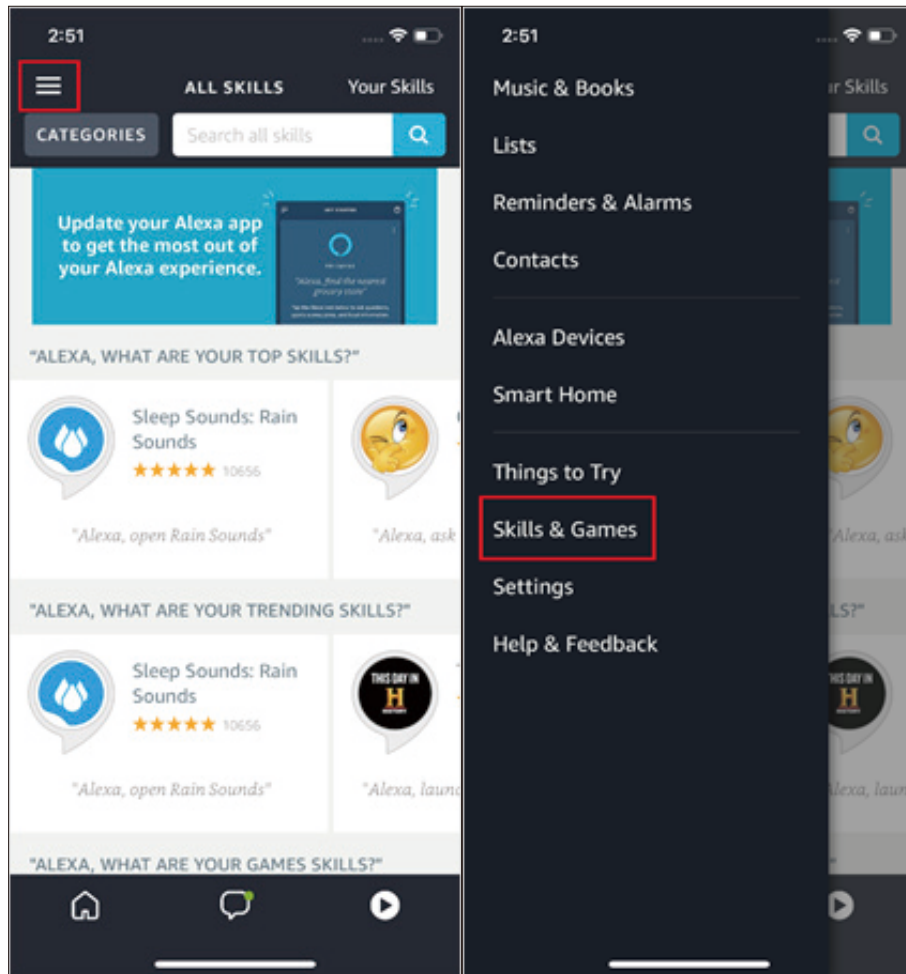

2. Enter [Tapo](#) in the search bar and choose [Tapo](#).

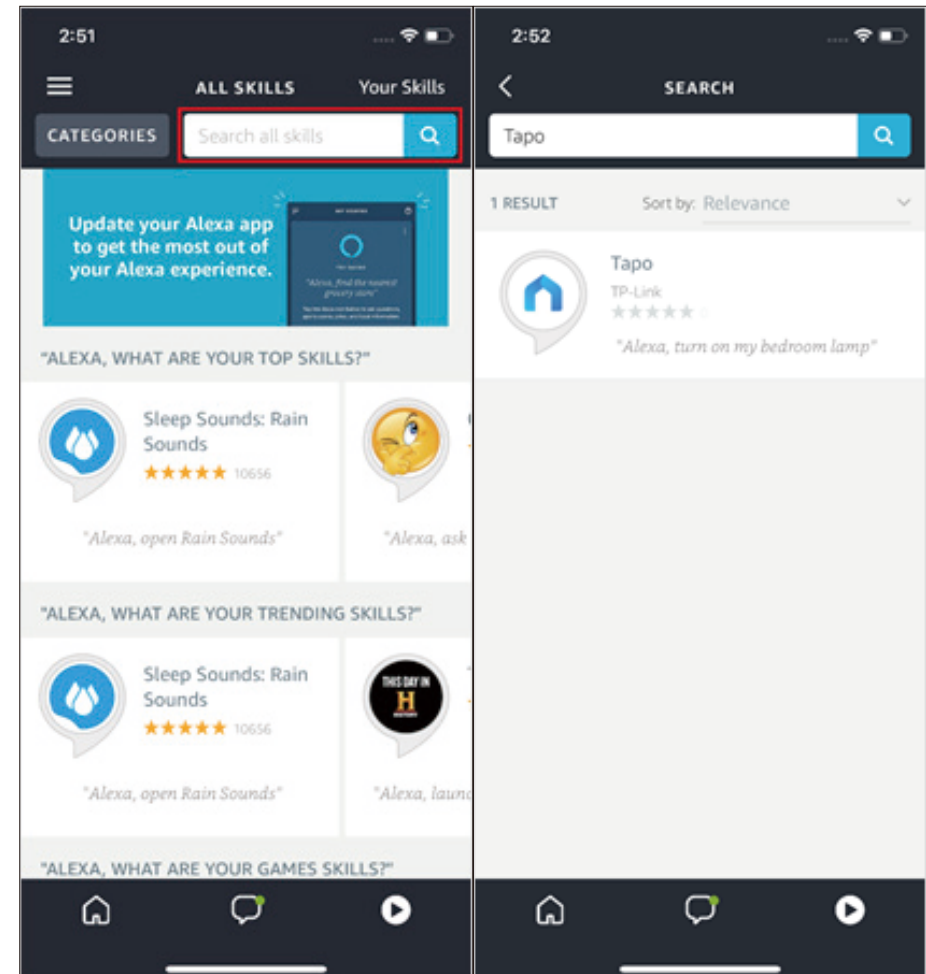

3. Tap the **ENABLE** button.

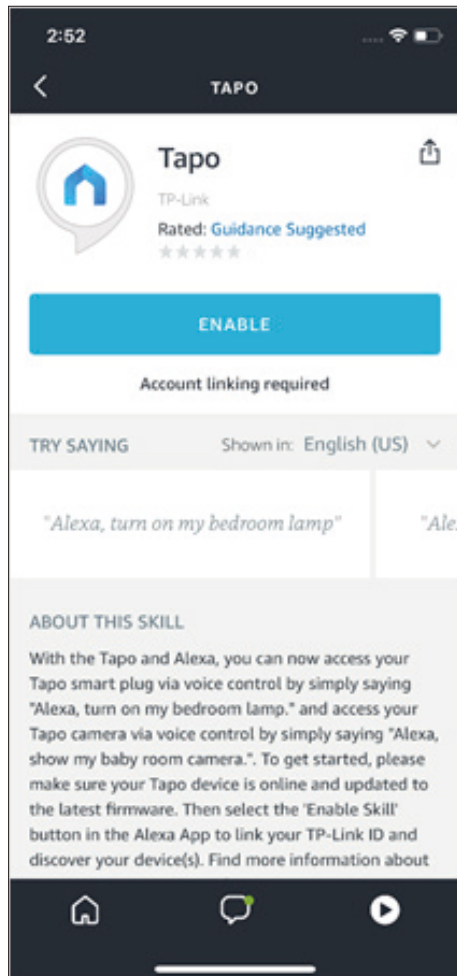

4. Log in with your TP-Link ID that has bound to your Tapo device, and tap **Authorize**. After authorized successfully, the message **Tapo has been successfully linked** will come up.

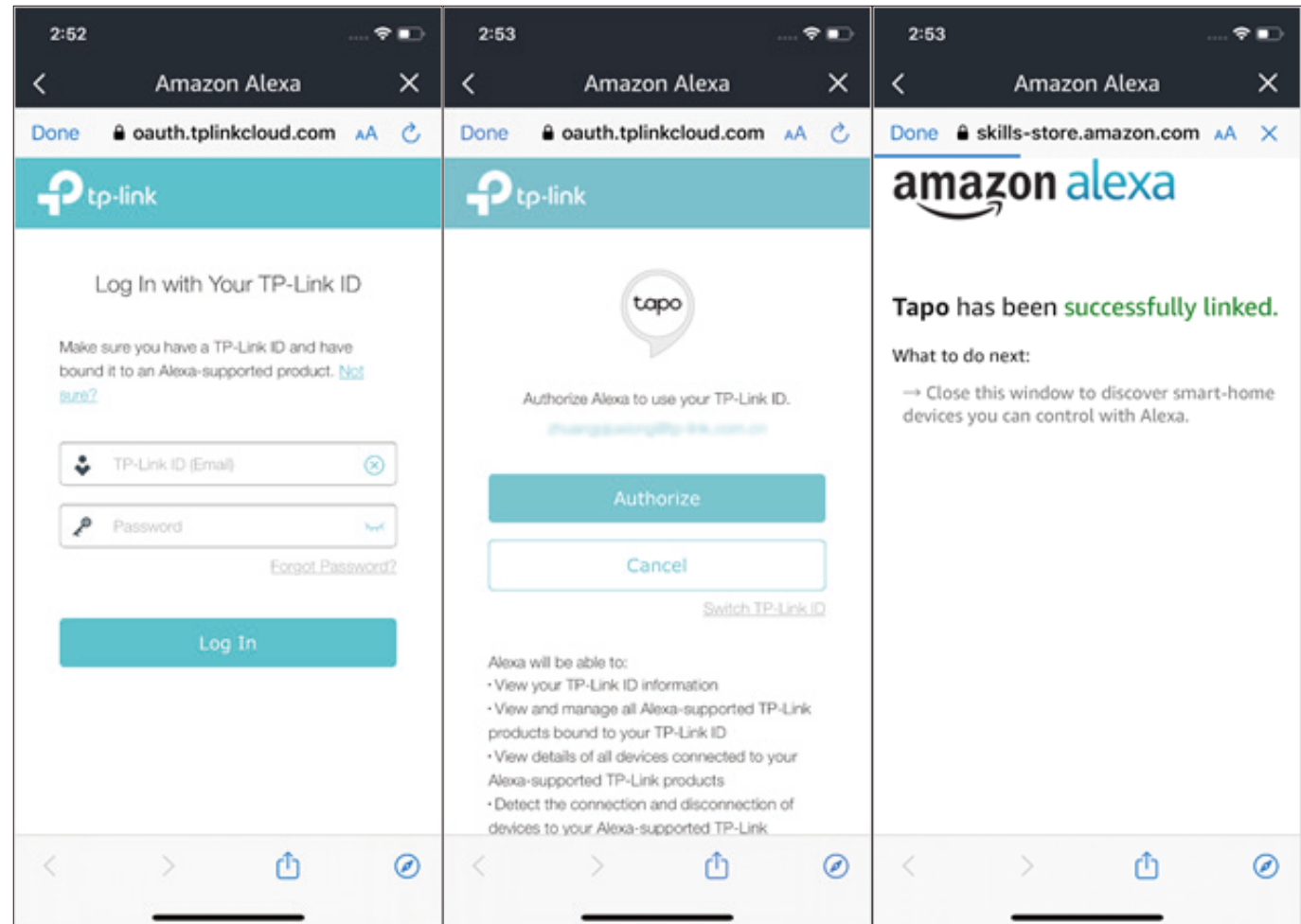

5. Plug in your Tapo device and the setup will complete automatically in two minutes.

For setting up more Tapo devices, just plug in and enjoy!

### **Done!**

If this device displays on the Home page in the Tapo app, it indicates this device has been successfully associated with your Amazon account and joined your Wi-Fi network automatically.

If this device does not display on the Home page in the Tapo app, try setting it up manually. (Tap the + button on the page, select your device model, and then follow the app instructions.)

# Main Camera Controls

After you successfully set up the camera, you will see your camera listed on the home page. You can view and manage your camera from anywhere at any time with the Tapo app.

## Home Page

This page lists all your cameras you've added and you can view them directly and manage them easily. Tap the camera or go to [Camera Preview](#) > [Manage](#) to enter the [Live View](#) page.

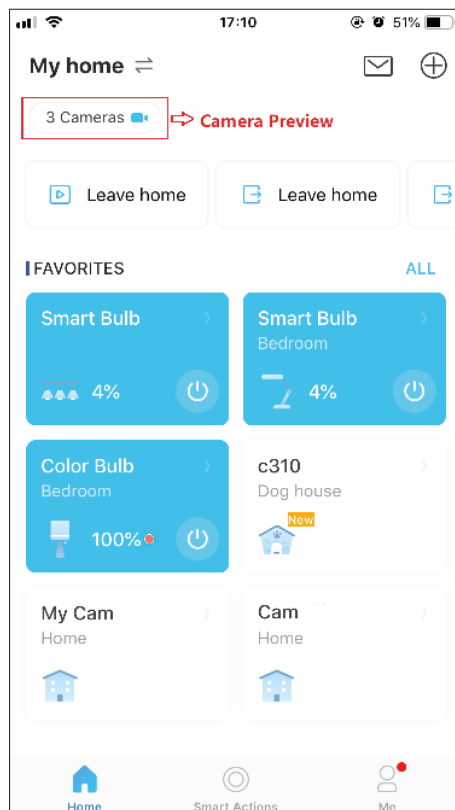

## Live View

[Talk](#) or [Voice Call](#): Communicate with loved ones

[Pan & Tilt](#): Rotate your camera to monitor every angle of your room

[Privacy Mode](#): Enable to temporarily shut down the surveillance for privacy

[Alarm](#): Turn on to get noticed when motion detected

[Playback & Memory](#): Check all recordings and saved moments

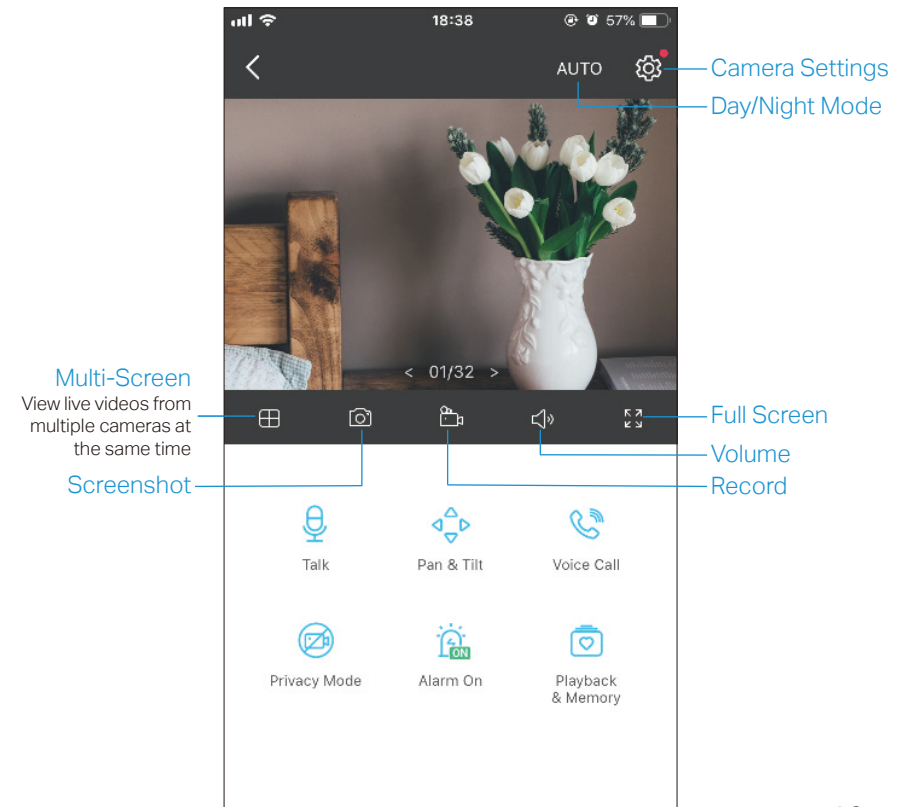

## Camera Settings

On [Live View](#) page, tap  to enter the [Camera Settings](#) page. You can change the settings of your camera to meet various needs, such as change your camera name, customize detection settings and recording schedules, turn on or off notifications, set activity zones, etc.

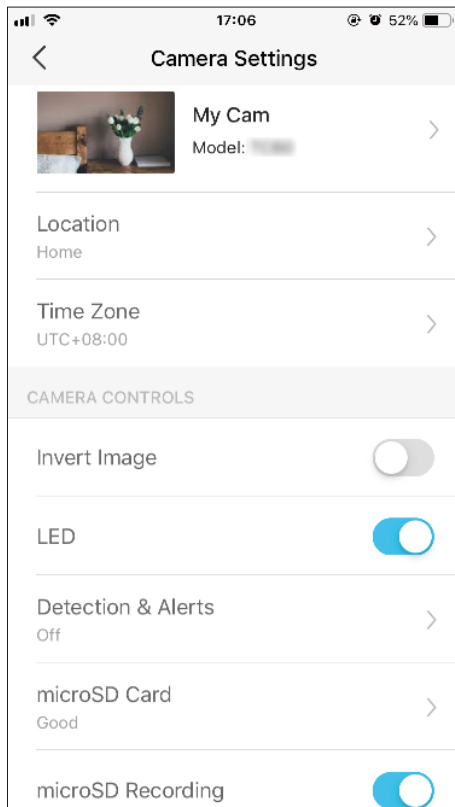

## Me

On this page, you can edit your account, quickly check the memorable moments you saved, or find the FAQs and other features related to the Tapo app.

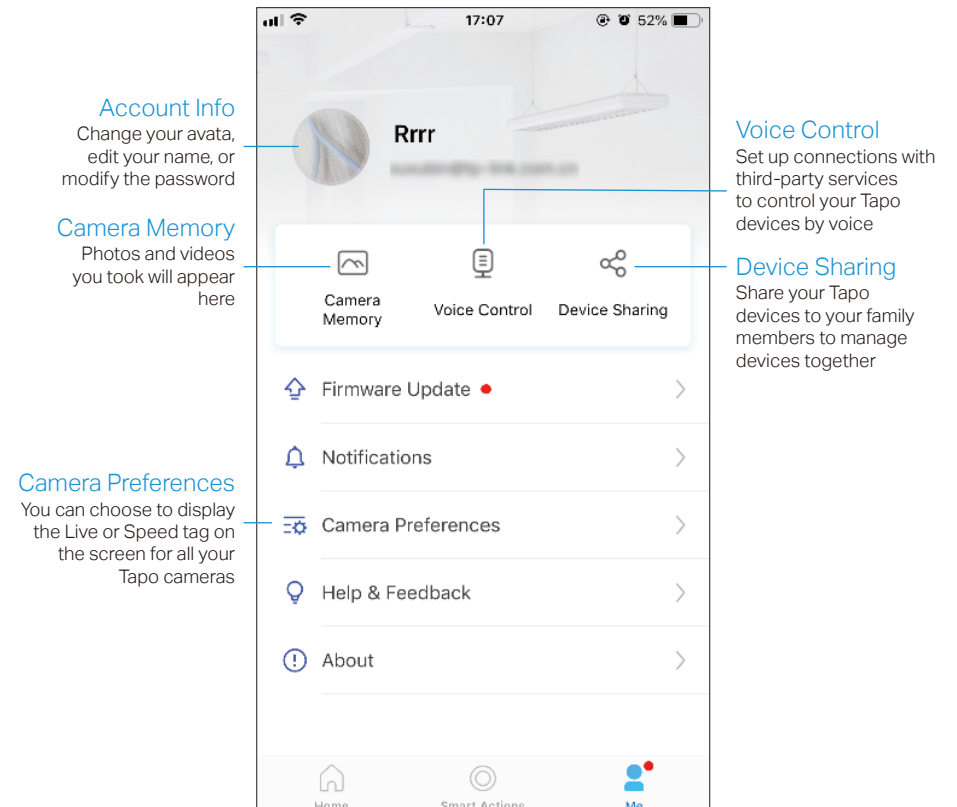

# Pan & Tilt Control

On the [Live View](#) page, tap  to enter the control page. Tap on the Pan & Tilt panel to control your camera to move.

[Pan & Tilt Settings](#): Tap  to set how many degrees the camera will move per tap of the Pan & Tilt.

[Vertical Cruise](#): Persistently move up and down.

[Horizontal Cruise](#): Persistently move from left to right.

[Mark Position](#): Tap to mark your current position, and then you can quickly rotate your camera to the marked direction with just a tap.

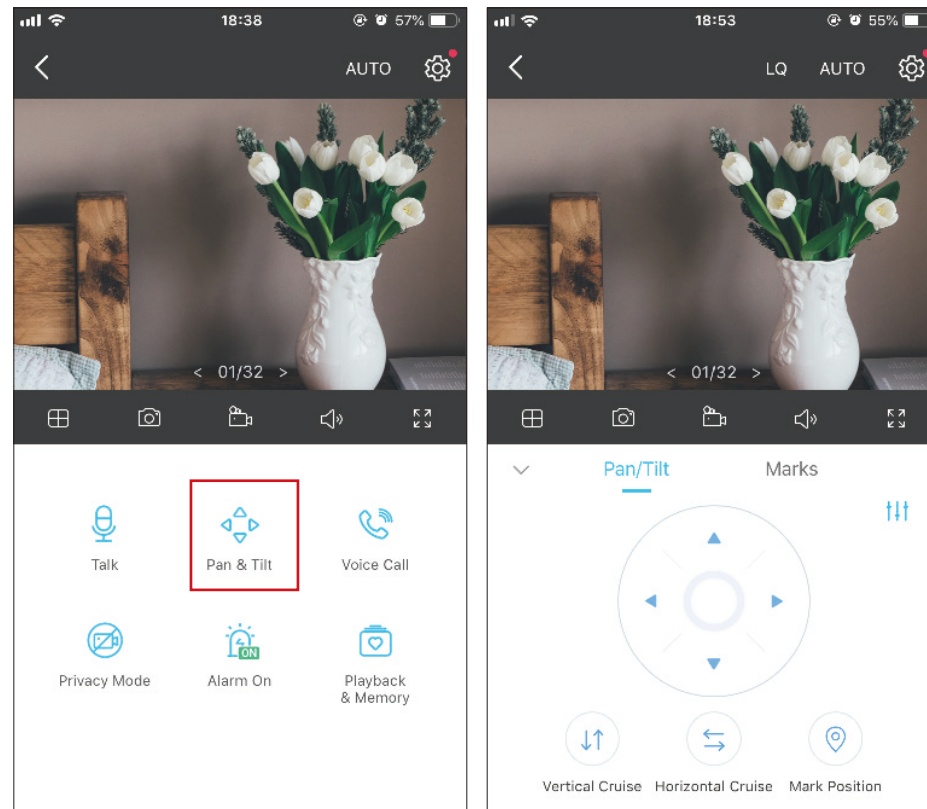

# Motion Detection

With motion detection, the Tapo app alerts you of activity that matters and sends notifications straight to you when motion detected. Insert a microSD card to record the clips when motion detected. Otherwise, you can only receive the notifications.

■ **Note:** Initialize the SD card on the app before using it.

1. Go to [Camera Settings](#) page and tap [Detection & Alerts](#) to customize its current detection settings.
2. On the [Detection & Alerts](#) page, enable the [Motion Detection](#) function. It's recommended to enable the [Notifications](#) function to receive motion detection messages.

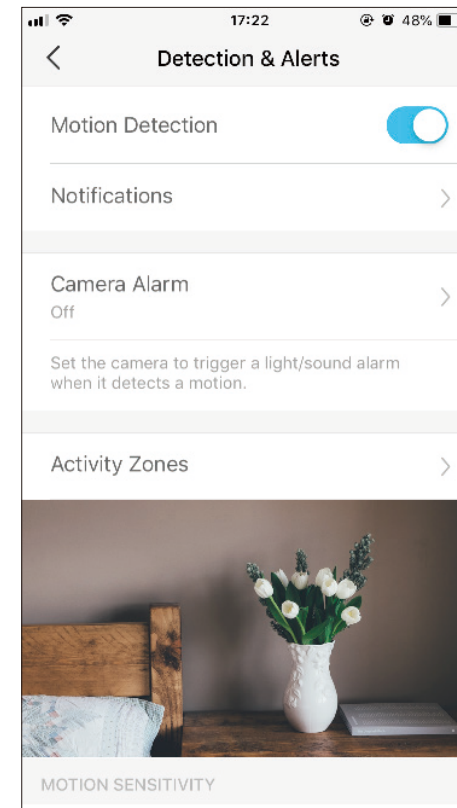
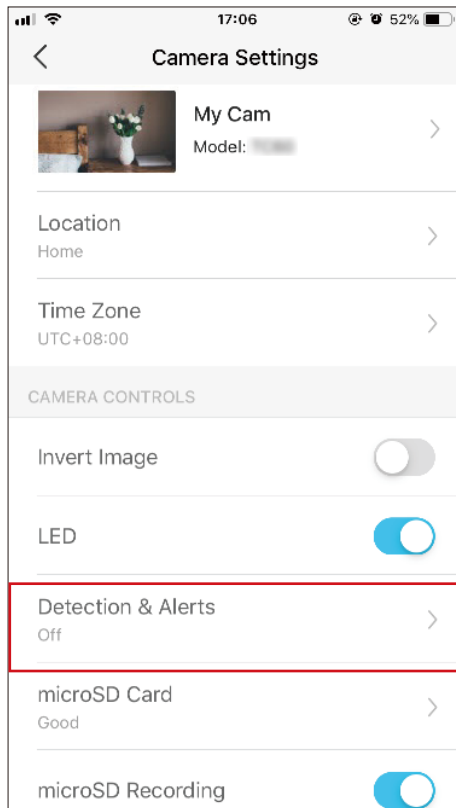

3. Customize [Camera Alarm](#) settings. Choose [Alarm Type](#) (Sound/Light) and [Alarm Sound](#) (Siren/Tone), and set [Alarm Schedule](#) as needed.

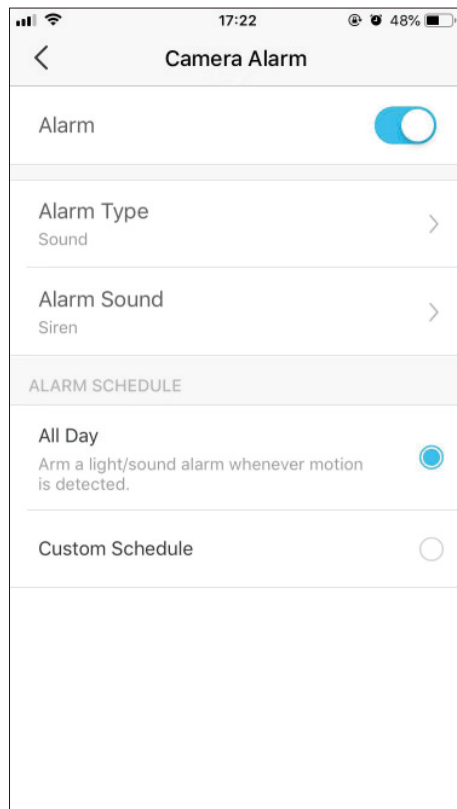

4. Customize [Activity Zones](#) and the camera will only detect motion in custom zones. Entire view is covered by default.

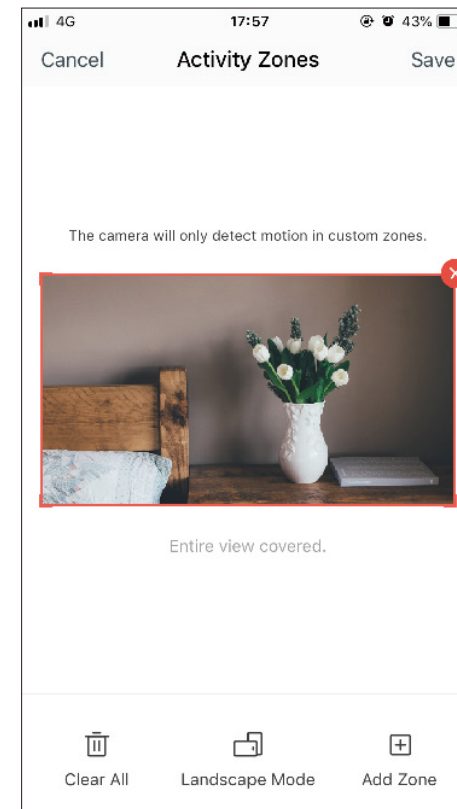



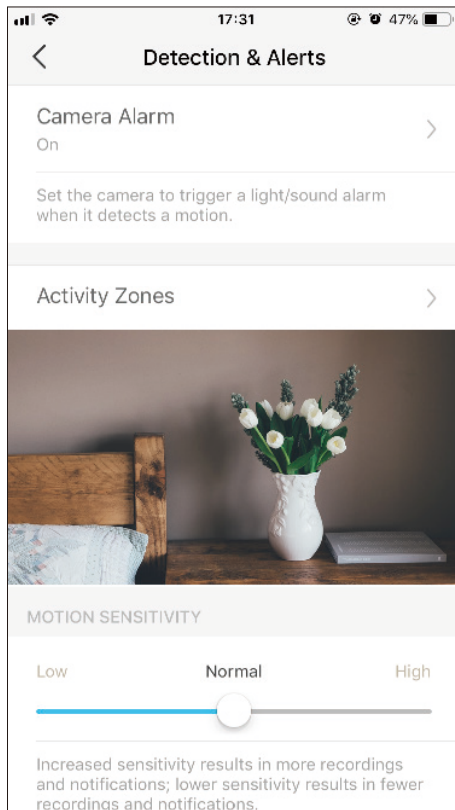

5. Adjust [Motion Sensitivity](#) (Low/Normal/High) as needed. Increased sensitivity results in more recordings and notifications.

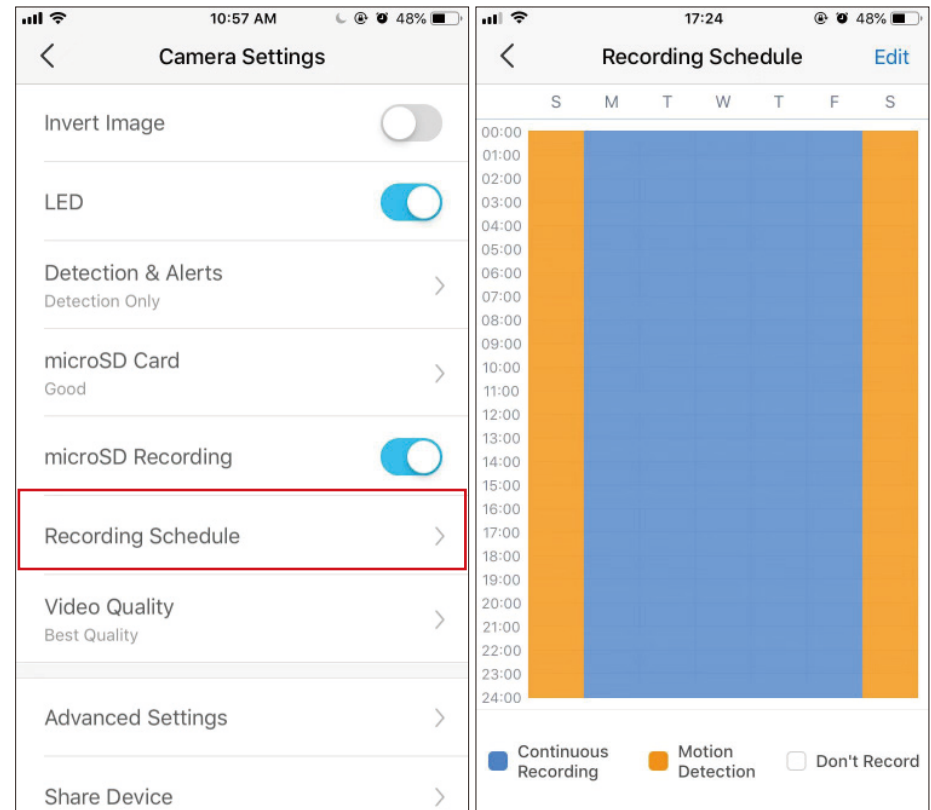

6. After editing the detection settings for the camera, you can set the [Recording Schedule](#) for the motion detection.



7. On the [Live View](#) page, tap  to find all recordings. The orange sections are recordings for motion detection.

**Note:** The microSD card is needed for recordings. Initialize the SD card on the app before using it.

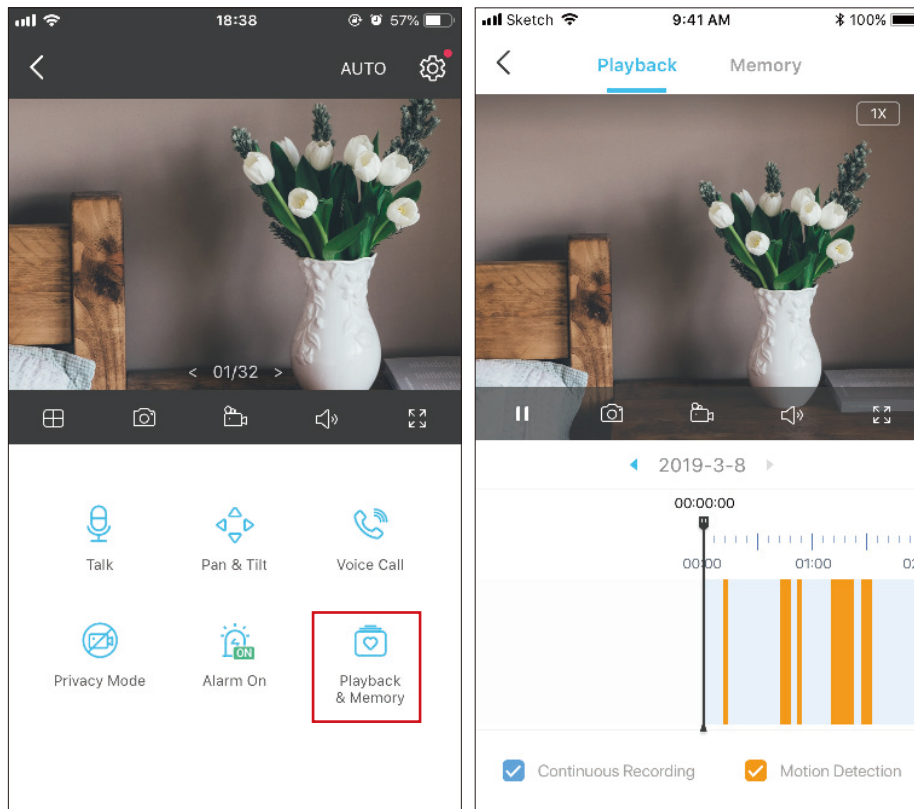

# 24-hour Recordings

The microSD card is needed for 24-hour recording and it's suggested to initialize the SD card on the app before using it.

1. On the [Live View](#) page, tap  to enter the [Camera Settings](#) page.

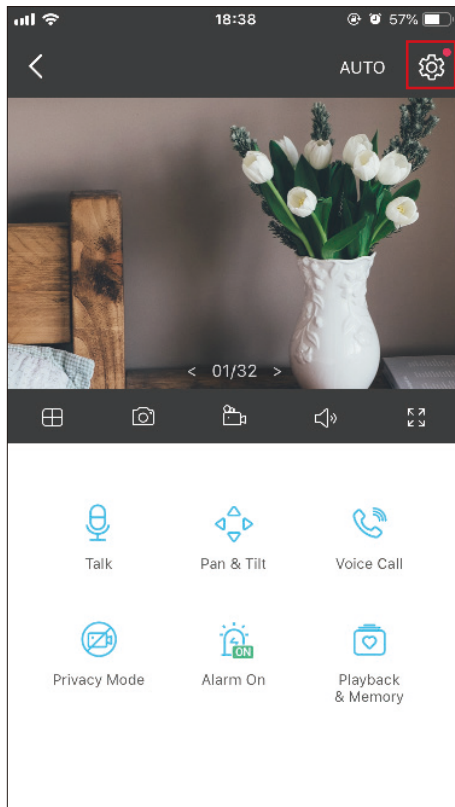

2. Toggle on to enable the [microSD Recording](#) function and set the [Recording Schedule](#) for [Continuous Recording](#) (24-hour Recording) as needed.

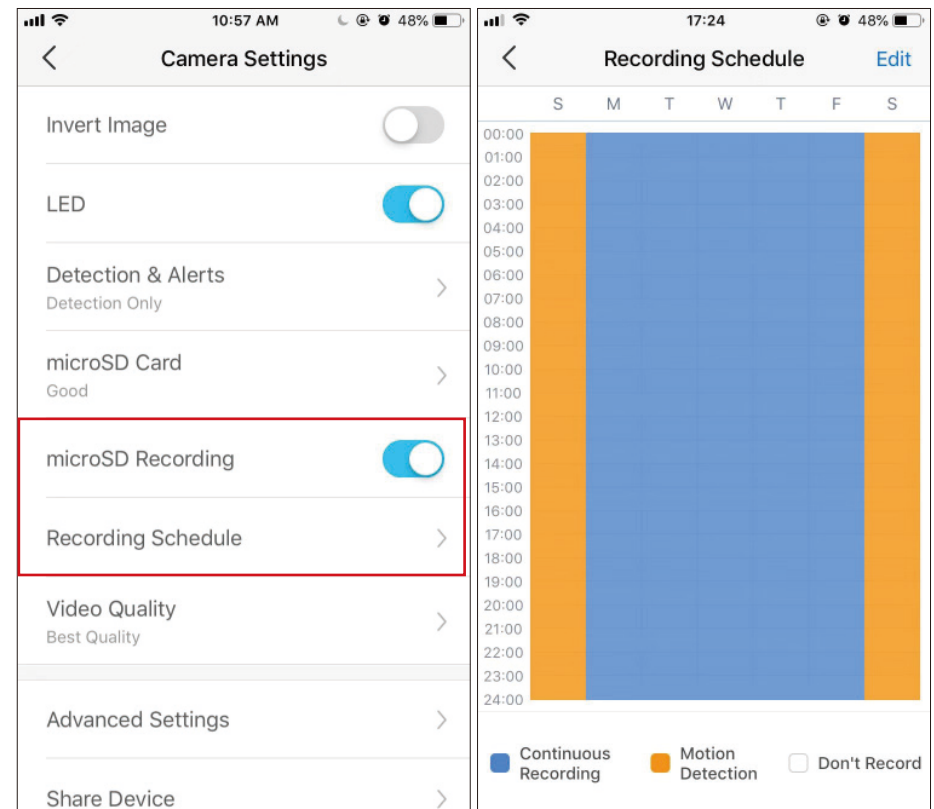

3. On the [Live View](#) page, tap  to find all recordings. The blue sections mean continuous recording.

**Note:** The microSD card is needed for recordings. Initialize the SD card on the app before using it.

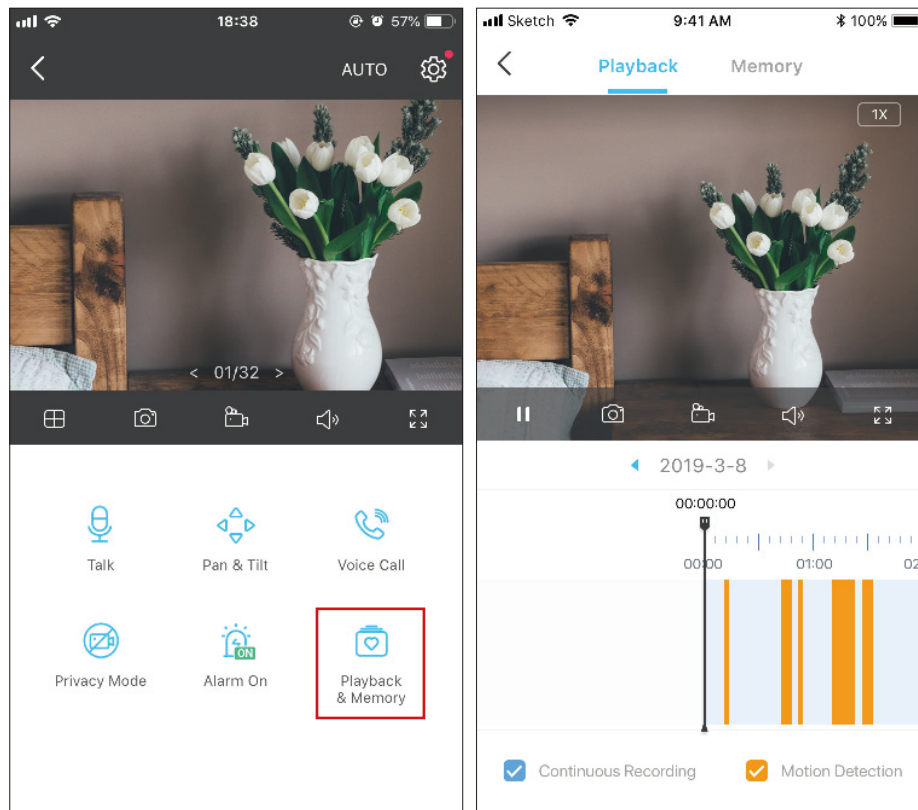

# Privacy Mode

On the [Live View](#) page, tap  to enable the Privacy Mode. When enabled, streaming and recording functions will be temporarily disabled to protect your privacy.

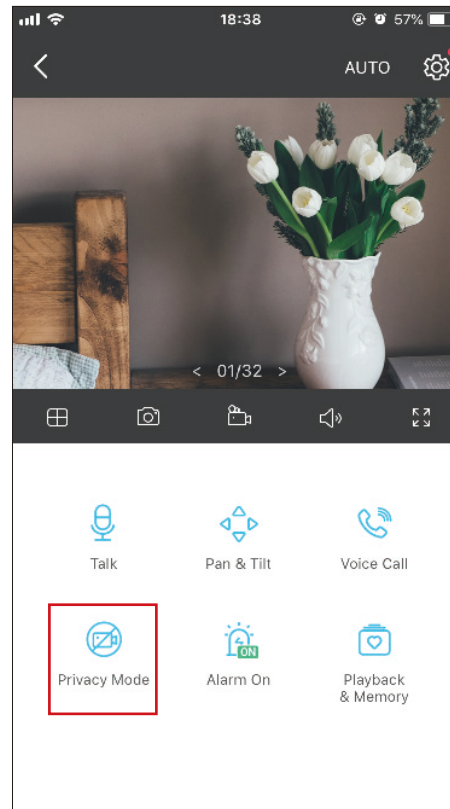

# Authentication

## FCC compliance information statement



**Product Name: Home Security Wi-Fi Camera**

**Model Number: Tapo C210**

| Component Name | Model       |
|----------------|-------------|
| AC ADAPTER     | T090060-2B1 |

### **Responsible Party:**

**TP-Link USA Corporation**

Address: 10 Mauchly, Irvine, CA 92618

Website: <http://www.tp-link.com/us/>

Tel: +1 626 333 0234

Fax: +1 909 527 6804

E-mail: [sales.usa@tp-link.com](mailto:sales.usa@tp-link.com)

This equipment has been tested and found to comply with the limits for a Class B digital device, pursuant to part 15 of the FCC Rules. These limits are designed to provide reasonable protection against harmful interference in a residential installation. This equipment generates, uses and can radiate radio frequency energy and, if not installed and used in accordance with the instructions, may cause harmful interference to radio communications. However, there is no guarantee that interference will not occur in a particular installation. If this equipment does cause harmful interference to radio or television reception, which can be determined by turning the equipment off and on, the user is encouraged to try to correct the interference by one or more of the following measures:

- Increase the separation between the equipment and receiver.
- Connect the equipment into an outlet on a circuit different from that to which the receiver is connected.
- Consult the dealer or an experienced radio/ TV technician for help.

This device complies with part 15 of the FCC Rules. Operation is subject to the following two conditions:

1. This device may not cause harmful interference.

2. This device must accept any interference received, including interference that may cause undesired operation.

Any changes or modifications not expressly approved by the party responsible for compliance could void the user's authority to operate the equipment.

Note: The manufacturer is not responsible for any radio or TV interference caused by unauthorized modifications to this equipment. Such modifications could void the user's authority to operate the equipment.

### **FCC RF Radiation Exposure Statement**

This equipment complies with FCC RF radiation exposure limits set forth for an uncontrolled environment. This device and its antenna must not be co-located or operating in conjunction with any other antenna or transmitter.

"To comply with FCC RF exposure compliance requirements, this grant is applicable to only Mobile Configurations. The antennas used for this transmitter must be installed to provide a separation distance of at least 20 cm from all persons and must not be co-located or operating in conjunction with any other antenna or transmitter."

We, **TP-Link USA Corporation**, has determined that the equipment shown as above has been shown to comply with the applicable technical standards, FCC part 15. There is no unauthorized change is made in the equipment and the equipment is properly maintained and operated.

**Issue Date: 2021-07-30**

### **FCC compliance information statement**

**Product Name: AC ADAPTER**

**Model Number: T090060-2B1**

**Responsible Party:**

**TP-Link USA Corporation**

Address: 10 Mauchly, Irvine, CA 92618

Website: <http://www.tp-link.com/us/>

Tel: +1 626 333 0234

Fax: +1 909 527 6804

E-mail: [sales.usa@tp-link.com](mailto:sales.usa@tp-link.com)

This equipment has been tested and found to comply with the limits for a Class B digital device, pursuant to part 15 of the FCC Rules. These limits are designed to provide reasonable protection against harmful interference in a residential installation. This equipment generates, uses

and can radiate radio frequency energy and, if not installed and used in accordance with the instructions, may cause harmful interference to radio communications. However, there is no guarantee that interference will not occur in a particular installation. If this equipment does cause harmful interference to radio or television reception, which can be determined by turning the equipment off and on, the user is encouraged to try to correct the interference by one or more of the following measures:

- Increase the separation between the equipment and receiver.
- Connect the equipment into an outlet on a circuit different from that to which the receiver is connected.
- Consult the dealer or an experienced radio/ TV technician for help.

This device complies with part 15 of the FCC Rules. Operation is subject to the following two conditions:

1. This device may not cause harmful interference.
2. This device must accept any interference received, including interference that may cause undesired operation.

Any changes or modifications not expressly approved by the party responsible for compliance could void the user's authority to operate the equipment.

We, **TP-Link USA Corporation**, has determined that the equipment shown as above has been shown to comply with the applicable technical standards, FCC part 15. There is no unauthorized change is made in the equipment and the equipment is properly maintained and operated.

**Issue Date:** 2021-07-30



## CE Mark Warning



This is a class B product. In a domestic environment, this product may cause radio interference, in which case the user may be required to take adequate measures.

## OPERATING FREQUENCY (the maximum transmitted power)

2412MHz - 2472MHz (20dBm)

## EU Declaration of Conformity

TP-Link hereby declares that the device is in compliance with the essential requirements and other relevant provisions of directives 2014/53/EU, 2009/125/EC, 2011/65/EU and (EU)2015/863.

The original EU Declaration of Conformity may be found at <https://www.tapo.com/en/support/ce/>.

## RF Exposure Information

This device meets the EU requirements (2014/53/EU Article 3.1a) on the limitation of exposure of the general public to electromagnetic fields by way of health protection.

The device complies with RF specifications when the device used at 20 cm from your body.

Restricted to indoor use.

## UKCA Mark



## UKCA Declaration of Conformity

TP-Link hereby declares that the device is in compliance with the essential requirements and other relevant provisions of the Electromagnetic Compatibility Regulations 2017 and Electrical Equipment (Safety) Regulations 2017.

The original UK Declaration of Conformity may be found at <https://www.tapo.com/support/ukca/>.

## Canadian Compliance Statement

This device contains licence-exempt transmitter(s)/receiver(s) that comply with Innovation, Science and Economic Development Canada's licence-exempt RSS(s). Operation is subject to the following two conditions:

1. This device may not cause interference.
2. This device must accept any interference, including interference that may cause undesired operation of the device.

L'émetteur/récepteur exempt de licence contenu dans le présent appareil est conforme aux CNR d'Innovation, Sciences et Développement économique Canada applicables aux appareils radio exempts de licence. L'exploitation est autorisée aux deux conditions suivantes :

1. l'appareil ne doit pas produire de brouillage;
2. l'utilisateur de l'appareil doit accepter tout brouillage radioélectrique subi, même si le brouillage est susceptible d'en compromettre le fonctionnement

## Radiation Exposure Statement:

This equipment complies with IC radiation exposure limits set forth for an uncontrolled environment. This equipment should be installed and operated with minimum distance 20cm between the radiator & your body.

## Déclaration d'exposition aux radiations:

Cet équipement est conforme aux limites d'exposition aux rayonnements IC établies pour un environnement non contrôlé. Cet équipement doit être installé et utilisé avec un minimum de 20 cm de distance entre la source de rayonnement et votre corps.

## Industry Canada Statement

CAN ICES-3 (B)/NMB-3(B)

## NCC Notice & BSMI Notice:

注意!

取得審驗證明之低功率射頻器材，非經核准，公司、商號或使用者均不得擅自變更頻率、加大功率或變更原設計之特性及功能。

低功率射頻器材之使用不得影響飛航安全及干擾合法通信；經發現有干擾現象時，應立即停用，並改善至無干擾時方得繼續使用。

前述合法通信，指依電信管理法規定作業之無線電通信。

低功率射頻器材須忍受合法通信或工業、科學及醫療用電波輻射性電機設備之干擾。

## 安全諮詢及注意事項

- 請使用原裝電源供應器或只能按照本產品注明的電源類型使用本產品。
- 清潔本產品之前請先拔掉電源線。請勿使用液體、噴霧清潔劑或濕布進行清潔。
- 注意防潮，請勿將水或其他液體潑灑到本產品上。
- 插槽與開口供通風使用，以確保本產品的操作可靠並防止過熱，請勿堵塞或覆蓋開口。
- 請勿將本產品置放於靠近熱源的地方。除非有正常的通風，否則不可放在密閉位置中。
- 請不要私自拆開機殼或自行維修，如產品有故障請與原廠或代理商聯繫。

## 限用物質含有情況標示聲明書

|  |  |                      |                      |   |   |   |
|--|--|----------------------|----------------------|---|---|---|
| 設備名稱：Pan/Tilt Home Security Wi-Fi Camera |  |                      |                      | 型號（型式）：Tapo C210                                  |   |   |
| Equipment name                           |  |                      |                      | Type designation (Type)                           |   |   |
| 單元<br>Unit                               | 限用物質及其化學符號                                     |                      |                      |   |   |   |
|  | Restricted substances and its chemical symbols |                      |                      |   |   |   |
|  | 鉛<br>Lead<br>(Pb)                              | 汞<br>Mercury<br>(Hg) | 鎘<br>Cadmium<br>(Cd) | 六價鉻<br>Hexavalent chromium<br>(Cr <sup>+6</sup> ) | 多溴聯苯<br>Polybrominated biphenyls<br>(PBB) | 多溴二苯醚<br>Polybrominated diphenyl ethers<br>(PBDE) |
| PCB                                      | ○  | ○                    | ○                    | ○   | ○   | ○   |
| 外殼                                       | ○  | ○                    | ○                    | ○   | ○   | ○   |
| 電源供應器                                    | —  | ○                    | ○                    | ○   | ○   | ○   |
| 其他及其<br>配件                               | —  | ○                    | ○                    | ○   | ○   | ○   |

設備名稱：Pan/Tilt Home Security Wi-Fi Camera

型號（型式）：Tapo C210

Equipment name

Type designation (Type)

備考 1. “超出 0.1 wt %” 及 “超出 0.01 wt %” 係指限用物質之百分比含量超出百分比含量基準值

Note 1: “Exceeding 0.1 wt %” and “exceeding 0.01 wt %” indicate that the percentage content of the restricted substance exceeds the reference percentage value of presence condition.

備考 2. “○” 係指該項限用物質之百分比含量未超出百分比含量基準值。

Note 2: “○” indicates that the percentage content of the restricted substance does not exceed the percentage of reference value of presence.

備考 3. “—” 係指該項限用物質為排除項目。

Note 3: The “—” indicates that the restricted substance corresponds to the exemption.



Продукт сертифіковано згідно с правилами системи УкрСЕПРО на відповідність вимогам нормативних документів та вимогам, що передбачені чинними законодавчими актами України.



## Safety Information

- Keep the device away from water, fire, humidity or hot environments.
- Do not attempt to disassemble, repair, or modify the device.
- Do not use damaged charger or USB cable to charge the device.
- Do not use any other chargers than those recommended
- Do not use the device where wireless devices are not allowed.
- Adapter shall be installed near the equipment and shall be easily accessible.





-  Use only power supplies which are provided by manufacturer and in the original packing of this product. If you have any questions, please don't hesitate to contact us.

Operating Temperature: 0 °C~ 40 °C (32°F ~ 104°F )

Storage Temperature: -40°C~70°C (-40°F ~ 158°F )

Please read and follow the above safety information when operating the device. We cannot guarantee that no accidents or damage will occur due to improper use of the device. Please use this product with care and operate at your own risk.

### Explanation of the symbols on the product label

| Symbol   | Explanation  |
|--|--|
|   | DC voltage   |
|   | Indoor use only  |
| <br> | <p>RECYCLING</p> <p>This product bears the selective sorting symbol for Waste electrical and electronic equipment (WEEE). This means that this product must be handled pursuant to European directive 2012/19/EU in order to be recycled or dismantled to minimize its impact on the environment.</p> <p>User has the choice to give his product to a competent recycling organization or to the retailer when he buys a new electrical or electronic equipment.</p> |